

P605L

NEMA 4 High Pressure High Set Point High Accuracy Pressure Switch

OVERVIEW

The Whitman Controls P605L NEMA 4 High Pressure High Set Point High Accuracy Pressure Switches are a line of severe application controls that can withstand massive pressure spikes from hydraulic systems. These switches can see pressure spikes to 9,000 psig without comprising switch integrity or functionality. They also afford the end user higher set points to complement more severe environments and low set point repeatability. The P605L is the NEMA 4 rated weather-proof, liquid-resistant version of the P605, suitable for outside applications or in areas of condensing humidity. The P605L switches feature adjustable Military or DIN electrical connectors plus numerous fitting options to meet any custom design.

KEY FEATURES

- Extremely durable - can withstand pressure spikes to 9,000 psig
- Higher set points to complement more severe environments
- NEMA 4 Rated
- Weather-proof and liquid resistant
- Set point options: Factory set, field adjustable, or a combination
- Extensive operating temperatures
- Wide range of electrical interfaces available
- SPDT or SPST availability

SPECIFICATIONS

- **Set Point Range:** 200 to 6,000 PSIG
- **Max System Pressure:** 9,000 PSIG
- **Temperature Range:** -65°F to +225°F (-54°C to +107°C)
- **Amps:** 5 Amps Max
- **Sensor Element:** Piston
- **Weight:** 7.0 oz (varies slightly with electrical interface selection)
- **Cycling:** Not to exceed 20 CPM
- **Wetted Parts:**
Limp Diaphragm: Kapton
Seal: Loctite #271
O-Ring: Viton standard, Teflon available
Adapter / Fitting: 303 Stainless steel
Standard Thread: 1/4-18 NP male

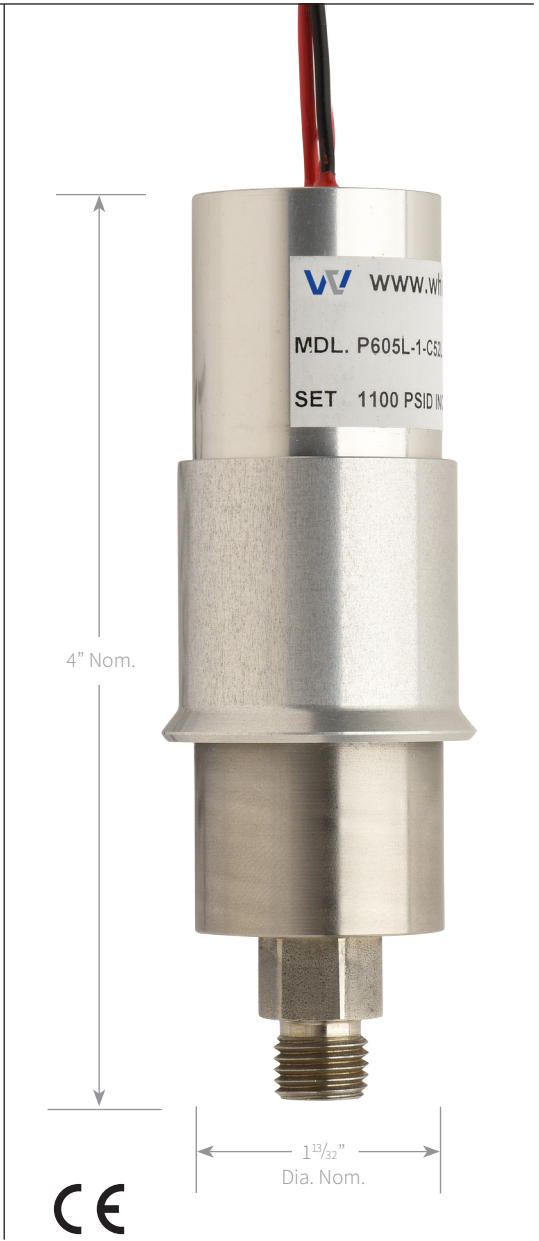

SENSOR CODE AND PERFORMANCE CHARACTERISTICS

Table A			Table B	
SENSOR CODE	MAXIMUM SYSTEM PRESSURE*	SET POINT REPEATABILITY	SET POINT RANGE	
	PSIG	PSIG	DECREASING PSIG	INCREASING PSIG
0	3000	± 25.0	200.0 - 600.0	200.0 - 600.0
1	3000	± 50.0	400.0 - 1500.0	400.0 - 1500.0
2	6000	± 150.0	1250.0 - 2750.0	1250.0 - 2750.0
3	9000	± 300.0	2750.0 - 5000.0	3500.0 - 6000.0

*Exceeding sensor capacity may cause shift in set point

CAUTION: Customer Media and environment must be compatible with construction materials as outlined above

All Pressure, Vacuum and Compound Switch Models Except P88, P90, P95

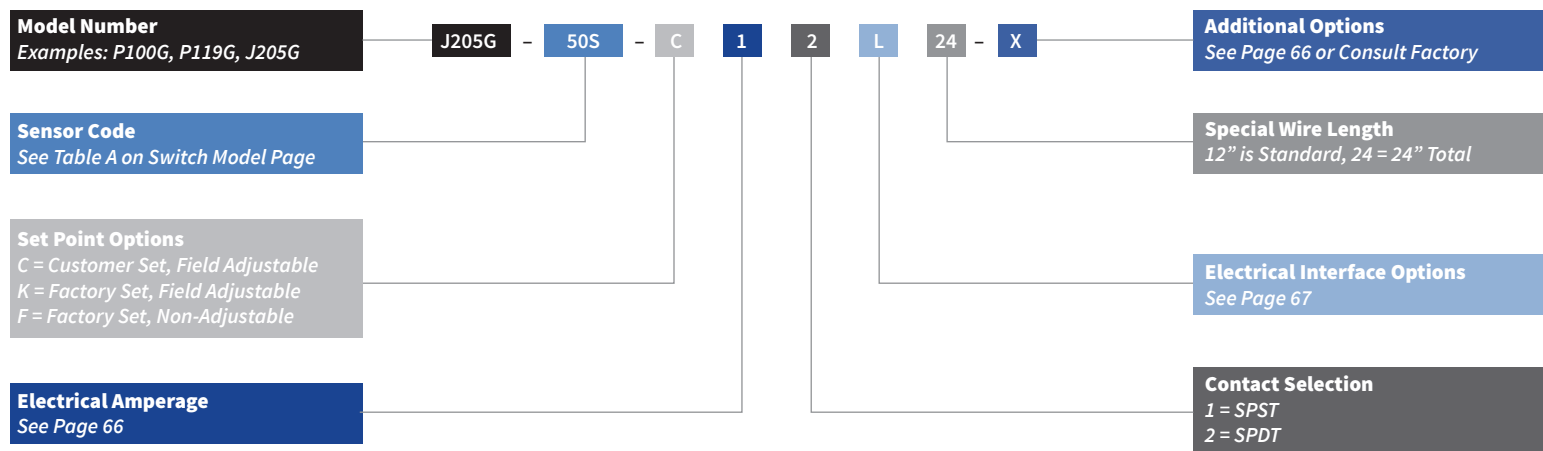

P88 Pressure, Vacuum, Compound Switches

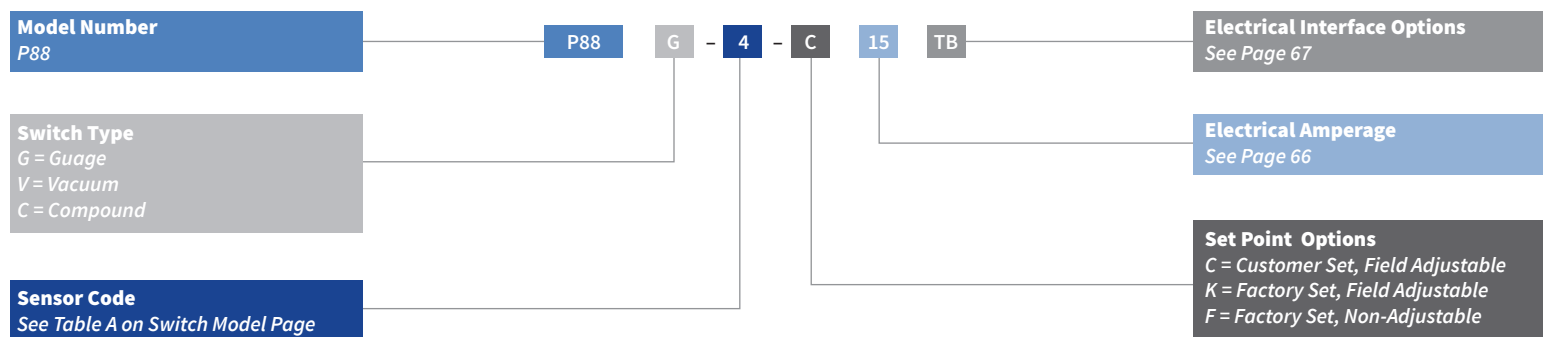

P90 / P95 Pressure Switch

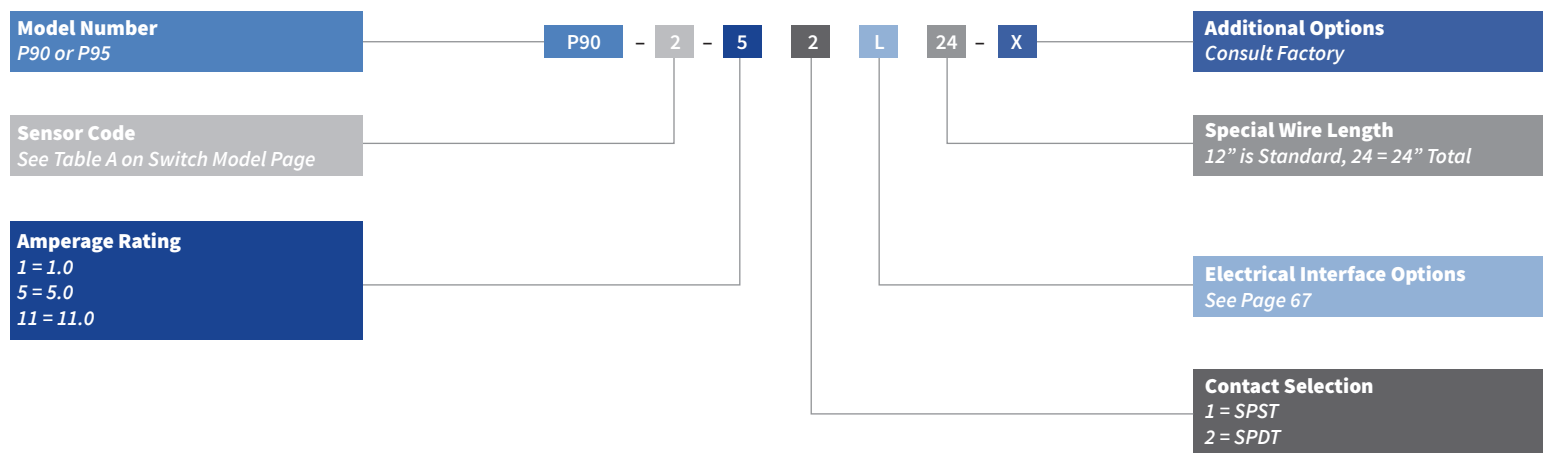

Electrical Switch Selection Tables

ALL MODELS EXCEPT P88, P90 & P95

SWITCH CODE	VOLTS AC / DC	AMP RESISTIVE	AMP INDUCTIVE	CONTACT MATERIAL
.1	125 / 30	.1	-	GOLD PLATE
1	115 / 28	1 / 1	1 / .5	GOLD
3	125 / 30	3 / 2	-	SILVER
5	250 / 28	5 / 5	5 / 3	SILVER

Above switches are SPDT, but may be used as SPST.

MODELS P90 & P95 ONLY

SWITCH CODE	VOLTS	AMP RESISTIVE	HORSE POWER @ 250 VAC	CONTACT MATERIAL
1	30 VDC / 125 VAC	1	-	GOLD
5	30 VDC / 250 VAC	5	-	SILVER
11	30 VDC / 250 VAC	10	1/4	SILVER

Above switches are SPDT, but may be used as SPST.

MODEL P88 ONLY

SWITCH CODE	VOLTS	AMP RESISTIVE	HORSE POWER @ 250 VAC	CONTACT MATERIAL
1	30 VDC / 125 VAC	1	-	GOLD
5	250 VAC	5	0.1	SILVER
10	250 VAC	10	1/3	SILVER
15	250 VAC	15	1/2	SILVER
25	250 VAC	25	2	SILVER

Above switches are SPDT but may be used as SPST. 25 Amp switch available on codes 4, 5, & 6 only.

For dry circuitry, i.e. 5VDC-50 mA or less, use gold contact switch (Code .1 or 1). If less than 20mA, performance of electrical switch will be environmentally dependent. If there is some form of contamination (dust, dirt, oil, chemical residue, etc.) at point of contact, the electrical switch could perform intermittently, as there would be insufficient current to burn off any possible contamination.

Optional Electrical Interfaces

Available for Models

P100, P117, P119, J205, P605, J705 and V117



T
Standard solder type terminals also accept AMP 60789-2 and 60598-4 Pin Receptacles

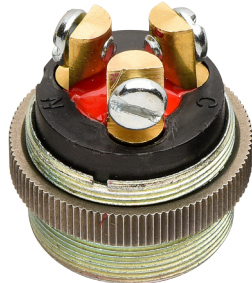

TS
Three flat bar terminals with #6-32 pan head screws at right angle

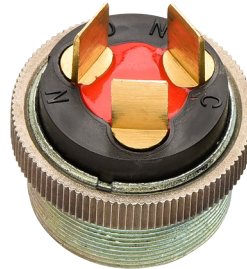

TB
3 standard 1/4" terminals accept arc-less (or equal) female quick connect terminals



DN
DIN Male Plug "F" Set Only Except "C", "K" & "F" Set on P605 Series Units

For L and U Electrical Interfaces

2 or 3 wire pigtail furnished in 12" length
Standard-supplied #20 AWG Insulated with polyvinyl chloride - 300 volts.

COLOR CODE:

- Black - Common
- White - N.O.
- Red - N.C.

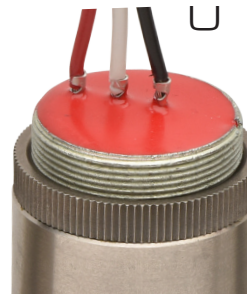
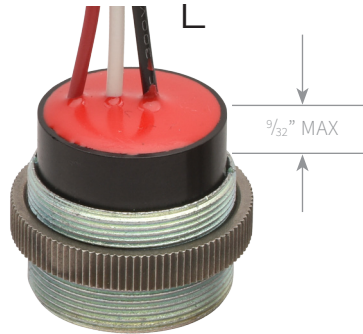

DN Pin-out:
1 = Common
2 = N/C
3 = N/O
Other Pin-outs on request

"M" Interface Quick-Disconnect 3-Pin Connector

This interface is rated as environmentally resisting. It is intended for use where the connector will be subjected to heavy condensation and rapid changes in environmental temperature or pressure. This connector is equivalent to MS3102E-10SL-3P. Applicable to models shown below only.

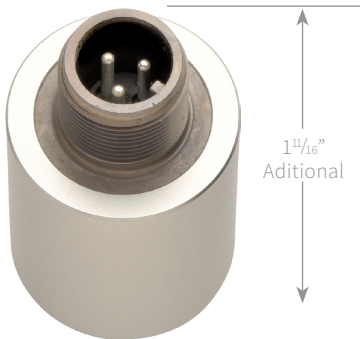

"M" Interface

P117, J705, J205, P605
"F" Set Only Except "C"
"K" and "F" Set on P605

MS3106E

Connectors - All Models
With "M" Interface

Interface Options

Optional Electrical Interfaces
Available for Model P88

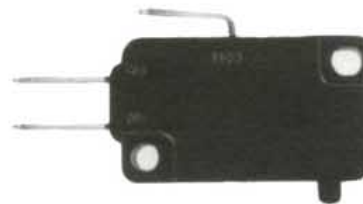

TB
1/4" (TB)
Blade terminals
UL Recognized
CSA Listed

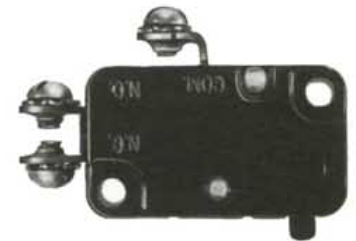

TS
Screw Terminal
UL Listed
(except 25 amp)
CSA Listed

Popular Options:

- **SPECIFIC RESET POINT RANGE** –(Calibrated Switch)
- **PIGTAILS** – Standard, Non-jacketed (“L” Interface)
12” long included in price, longer lengths available
18 AWG, 20 AWG Wire in various colors
- **PIGTAIL WITH PVC JACKET** (“L” Interface)
12” length, longer lengths available
- **UL and/or CSA – Consult Factory**
Some product is covered by UL-CSA approval under the following file numbers: UL E 109178 – CSA LR62173 – P88, P117, W117, P119, J205.
UL E 123402 – CSA LR87500 – Wiring harness
- **PIN RECEPTACLE – AMP 60598-4 or equal**
Three per set (“T” interface)
- **VOLTAGE SPIKE ARRESTOR – AC/DC Voltage,**
SPST/SPDT Switches
- **BAR CODING**
- **R/C CIRCUITS FOR CURRENT BELOW 10mA**
- **O-RINGS (J205, P605, J705 only)**
Special materials upon request
- **ROLL STAMPING/STENCILING**
- **COMPUTER DIAGNOSIS CAPABILITY**
- **SHRINK TUBING**
- **CONVOLUTED CONDUIT**
- **LABELING**
- **TEFLON TAPE** – Available on NPT Fittings
- **THREAD LOCKER** – Available on all Fittings

Adapters:

Models P100, P119 and J705 are available with optional port thread adapters.



1/8” NPT to 1/4” NPT



1/8” NPT to 7/16-20 SAE



1/8” NPT to 9/16-18 SAE

Fittings:

Most models can be obtained with a variety of fittings. Some common fittings are shown below. Please specify when ordering.

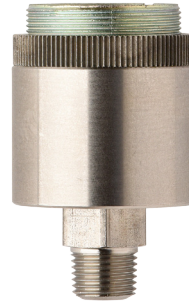

1/8 NPT Fitting
(Optional for P605)

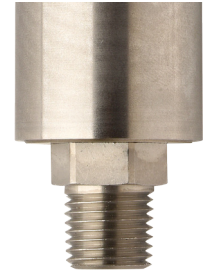

1/4 NPT Fitting
(Optional for P117, P119 J205, W117)



7/16-20 Thread Fitting
(Optional for P117, J205)

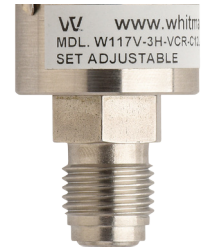

1/4” VCR Fitting
(Optional for P117, W117, J205)

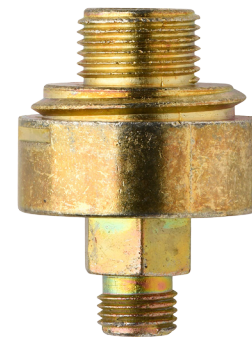

1/2-20 SAE Fitting with Optional O-Ring
(Optional zinc diecast for P90)
(Optional stainless steel for P95)

Set Point Adjustments and Wiring Instructions

SET POINT ADJUSTMENTS

PRESSURE SWITCHES

PRESSURE SET POINT ADJUSTMENT-JAM NUT STYLE ADJUSTING RING MODELS P100, P117, W117, P119, J205, J705 -K OR C SET.

The K & C designs are readily adjustable throughout their prescribed range by loosening the knurled locking ring. Turning the electrical switch clockwise will lower the set point, turning it counterclockwise will increase the set point. When desired set point is reached, the assembly is locked again by tightening the knurled locking ring.

Entire adjustable range may be covered by rotating approximately 250° each side of the mean.

The knurled locking ring requires very little effort to establish a reliable locked position. By placing a wrench on the fitting hex to hold switch body in position, grip the knurled locking ring with pliers and turn counterclockwise to loosen or clockwise to tighten. Only a slight snug is required to lock in position.

VACUUM SET POINT ADJUSTMENT – VACUUM MODELS

To lower set point turn electrical switch counterclockwise. To raise set point turn electrical switch clockwise.

PRESSURE SET POINT ADJUSTMENT – MODEL P605

Slide spring clip cover down past adjusting ring window. Insert .093 inch dia. pin into adjusting ring radial hole. Pushing the pin to the right (counterclockwise) will lower the set point: to the left (clockwise) will raise the set point. Align center of pin holes to the desired pressure. When desired set point is reached, remove pin and slide up the cover to close the adjusting ring window.

PRESSURE SET POINT ADJUSTMENT MODEL P88 K OR C SET

The standard field adjustable versions of the Guardian P/V Model P88 are easily adjusted throughout the prescribed pressure range by aligning the top of the knurled adjusting nut with the desired pressure setting indicated on the adjacent range scale.

PRESSURE SET POINT FOR ADJUSTABLE SWITCHES

All switches are easy to adjust. First, loosen the knurled locking ring. Now, set the sliding gauge pointer to the desired pressure point. Tighten the locking ring and the pressure (vacuum) switch is locked and ready to use.

NOTE: Little effort is required to establish a reliable locked position. If tools are used, place a wrench on the hex nut under the switch to hold the switch body in place; then grip the knurled locking ring with pliers to tighten or loosen as desired.

Loosen knurled ring, set pointer to desired pressure and tighten ring to hold in position.



Knurled Locking Ring

On P605 Models, insert the pin (provided) into the adjusting ring and align center of pin holes to the desired pressure.



WIRING INSTRUCTIONS

MODELS P90, P95, P100, P117, P119, J205, J705, P605, W117

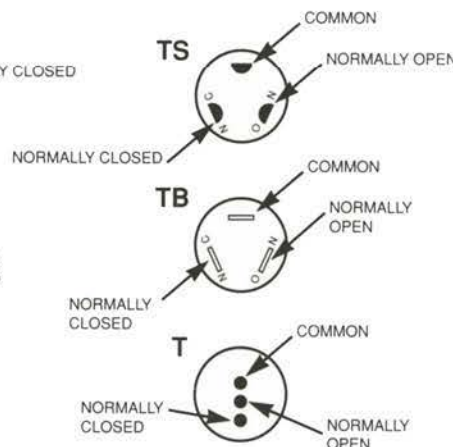
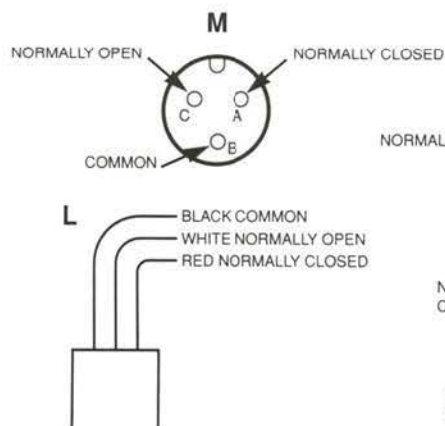

MODEL P88

Type TB [Terminal Blades]

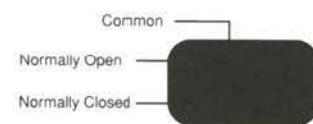

Type TS [Terminal Screws]

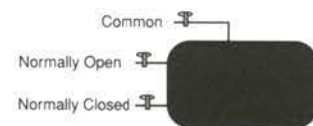

WHITMAN VALUE

High Quality Switches, Fully Customizable, with an Unrelenting Focus on Superior Service

Whitman Controls has been a leader in the pressure, vacuum, and liquid level switch industry for over 40 years. The Whitman Value is built on our differentiated offering of high quality switches, and the ability to deliver product to EXACT customer specifications in two weeks or less. Off the shelf switches limit an application's functionality and versatility - Why choose a competitor switch that results in inferior performance? We take into account your application and media environment, as well as all desired specifications to design a switch that will meet performance needs and exceed your expectations. Quality switches, designed to customer specifications in two weeks or less, with an unrelenting focus on superior service - Together they add up to the Whitman Value.

ISO 9001 Certified – We Hold Ourselves, and Our Products, to the Highest Standards

Whitman Controls is ISO 9001:2015 Certified, which gives our customers the confidence that we hold our internal processes, and products, to the highest standards of quality and rigorous testing requirements. You can be confident that the product you receive has met all necessary regulatory requirements and will outperform your desired expectations.

Experience and Knowledge, That's Invaluable.

Whitman Controls directs its years of design and manufacturing experience toward providing value-added services to our customers. These services can help you lower costs and increase efficiency. Our engineering team will work intimately with you and your team to design a switch that will maximize application performance no matter what the environment. In addition, our exceptional mechanical abilities allow us to perform additional assemblies and deliver more complete tested systems and subassemblies.

Diversified Product Offering – More Choices and More Savings.

We offer the most extensive pressure, vacuum, and liquid level switch offering in the industry. What does this mean for you? The ability to identify a switch that is suited perfectly for your application at a price that doesn't break your budget. At Whitman, we are constantly evaluating our input prices to identify savings we can pass along directly to the buyer. And we do all of this without sacrificing performance and quality.

Numerous Choices and Additional Options – Have it your Way.

Need additional wire on top of the 12" standard offering? Looking for a 1/4" NPT fitting instead of 1/8" NPT? Need Teflon tape or Loctite Vibraseal on your fitting? These are just a few of the numerous additional options that are available to customers on all our switch offerings. You have a need and we have an answer. All our switches can be customized to meet any end-user requirements.

At the Other End, Whitman Can Handle Wire Harness Assemblies Too.

As a UL and CSA approved harness assembly house, Whitman can do your next level of assembly. With our capabilities we can provide "value-added" benefits top to bottom. Whitman can guarantee leak free subassemblies and can handle a wide variety of switch mounts in customer designed systems. From T's to elbows, we will purchase and assemble parts and switches to your specifications.

Plus we can do it all at a price that will save you money. Call or email us today and we will give you a quotation on your assembly project.

Quality products, fully customizable, with a commitment to superior service. Together they add up to the Whitman Value.

